

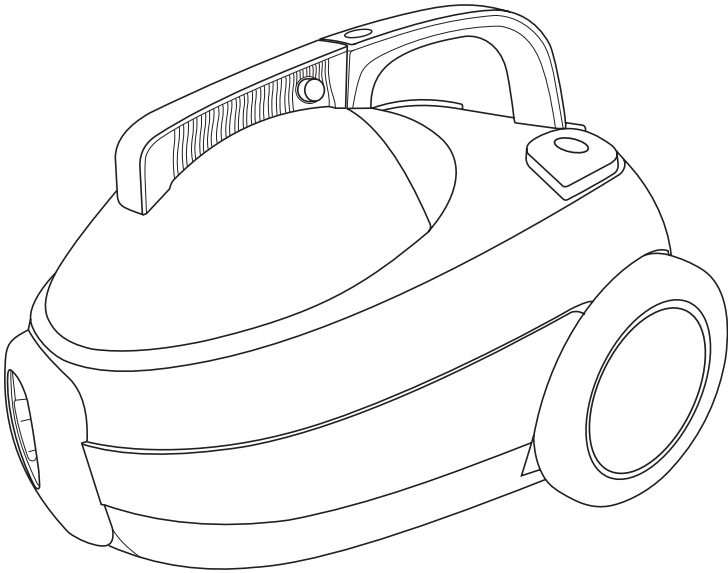

Electrolux



**OWNERS HANDBOOK
FOR CYLINDER VACUUM CLEANERS
MODEL: Z1660**

Welcome to the worldwide club of **Electrolux** appliances.
Please read these operating instructions before operating your vacuum cleaner.

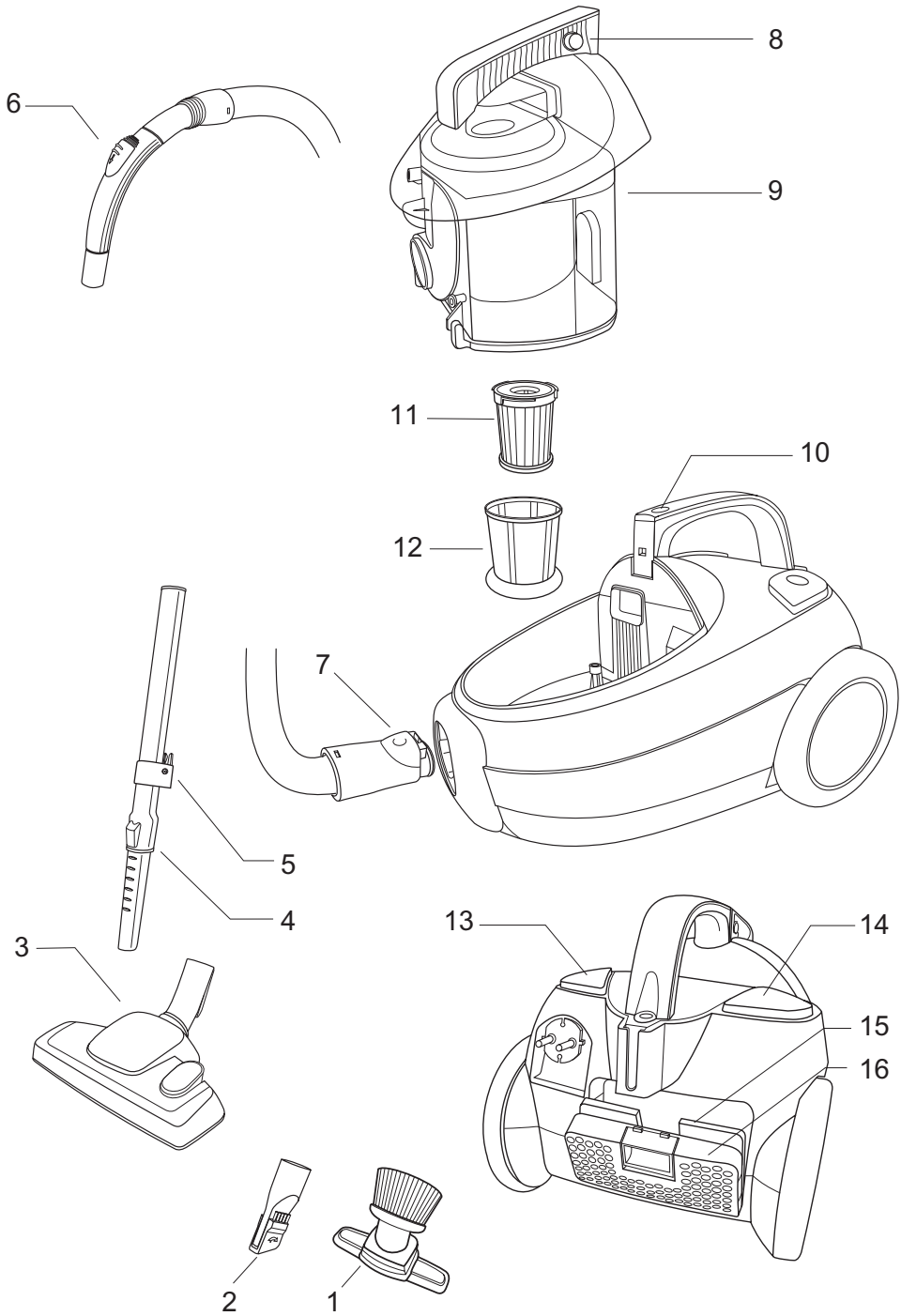

- | | | | |
|---|--|----|---------------------|
| 1 | Combination Upholstery \ Brush nozzle. | 9 | Dust container |
| 2 | Combination Crevice \ Brush nozzle | 10 | Filter indicator |
| 3 | Combination floor nozzle | 11 | HEPA filter |
| 4 | Telescopic extension tube | 12 | Cage filter |
| 5 | Caddy | 13 | Cord rewind pedal |
| 6 | Handle | 14 | On\Off Pedal switch |
| 7 | Hose end | 15 | Exhaust filter |
| 8 | Dust container release button | 16 | Air outlet grille |

IMPORTANT USER INFORMATION

Dear Customer, please read through these operating instructions carefully. Above all, please observe the safety instructions on the first few pages of this booklet. Please keep these operating instructions for later reference and pass them on to any subsequent owner of this appliance.

The safety standards of Electrolux electrical appliances are in keeping with the recognised rules of technology and the laws governing the safety of appliances. Prior to operating this appliance please familiarise yourself with the following safety instructions:

Safety Instructions

- Read all the instructions and only use the appliance for its intended purpose.
- The appliance must be switched off before plugging or unplugging it from the wall socket. Do not pull on the electrical cord to remove the plug from the wall socket.
- Always remove the plug from the wall socket before attempting any form of user maintenance or cleaning, as specified in this booklet.
- Do not handle the plug with wet hands.
- Do not operate the appliance with a damaged electrical cord or plug. If the electrical cord is damaged it must be replaced by returning the product to an authorised Electrolux service centre or similar qualified person to avoid a hazard.
- If the appliance has malfunctioned or been damaged in any manner return the appliance to the nearest authorised Electrolux service centre for examination, repair or adjustment.
- Do not carry or drag the appliance by the electrical cord.
- Keep the electrical cord away from heat, oil, sharp edges and rough or

hot surfaces and do not run the appliance over the cord.

- Hold onto the plug when rewinding the electrical cord to prevent the plug from whipping or hitting hard against the appliance.
- An extension electrical cord may be used provided that it has a higher rating than the appliance. Please refer to the information provided on the appliance's rating plate or consult with your nearest authorized Electrolux service centre.
- To protect against electric shock do not immerse the electrical cord, plug or the appliance in water or other liquids.
- Do not expose the appliance to rain.
- Do not use the appliance out of doors.
- Never leave the appliance running unattended.
- This appliance is not intended for use by young children or infirm persons without supervision.
- Young children must be supervised to ensure that they do not play with the appliance.
- Close attention is necessary when using the appliance near children.
- Store the appliance away from high heat sources.
- Do not use this appliance to vacuum up the following:
 - ⊙ Inflammable or combustible substances,
 - ⊙ Hard pointed objects,
 - ⊙ Hot ash, lighted cigarette ends or anything that is burning or smoking,
 - ⊙ Large quantities of fine dust e.g. lime, cement or plaster dust, toner dust from laser printers etc
 - ⊙ Liquids or carpet cleaning foams
- Do not operate this appliance in areas where the substances listed above may be present.
- To prevent the reduction in air flow, ensure that all orifices/vents on this appliance are kept free from blockages and do not insert any objects into these orifices/vents.
- Extra care should be taken when vacuuming staircases.
- It is dangerous to alter the specifications or modify the vacuum cleaner, only use accessories recommended by Electrolux.
- Under no circumstances should the customer attempt to repair the vacuum cleaner.
- The vacuum cleaner should only be repaired and/or serviced by an authorized Electrolux service centre and only genuine Electrolux spare parts should be used. Failure to do so may render the warranty void.

This vacuum cleaner is for household use only.

Important!

This vacuum cleaner must only be connected to a power supply whose voltage and frequency comply with the specifications given on the appliance rating plate.

BEFORE USING THE CLEANER

- Unpack the appliance and remove all the packaging materials.
- Carefully study the safety instructions listed in the Important User Information.

OPERATING THE CLEANER

Caution: Always ensure that the cleaner is unplugged from the wall socket before fitting or removing accessories.

Never operate the cleaner without the filters in place or with dirty and clogged filters.

Do not operate the cleaner with wet hands.

1. Insert the hose end into the air intake duct and push until the catch clicks into position. To remove the hose press the catch release button and pull hose end out of the intake duct.
2. Attach the extension tube to the hose handle and the desired floor nozzle to the other end of the extension tube. To remove the extension tube or the accessory twist and pull apart.

Note: On model Z1660 (with telescopic extension tubes) the length of the extension tubes can be adjusted by pressing down on the release button on the outer tube and sliding the inner tube.

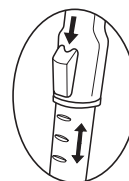

3. Pull the required length of electrical cord out of the cleaner and connect the plug to the wall socket.

Note: The yellow mark on the electrical cord indicates the maximum length of usable cord. Never unwind the electrical cord beyond the red mark.

4. Press the on/off foot pedal to switch the cleaner on.
5. The suction power can be adjusted by opening or closing the aperture on the hose handle.

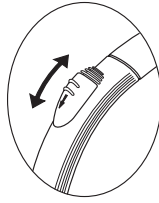

When finished cleaning, switch off the cleaner before rewinding the electrical cord. Unplug the cleaner from the wall socket and press the cord rewind pedal. Hold the plug with one hand and guide the electrical cord with the other hand to prevent it from striking you or the cleaner.

SELECTING ACCESSORIES

Combination floor nozzle

The combination floor nozzle can be set for hard floors or carpets. Press the foot operated toggle lever on the floor nozzle to select the desired setting.

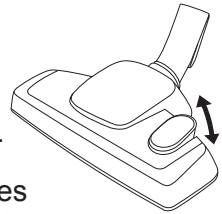

When the floor nozzle is set for hard floors, the bristles will extend beyond the base of the floor nozzle. When the floor nozzle is set for carpets, the bristles will be retracted.

Combination upholstery and brush nozzle

This nozzle can be used for upholstery or brushing. To clean upholstery, open the two flaps on the nozzle and attach it with the bristle side facing the extension tube.

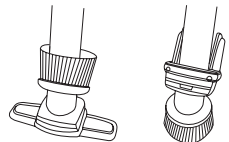

To use the brush side of the nozzle, close the two flaps and attach the nozzle to the extension tube.

Combination crevice nozzle and dusting brush

This nozzle can be used as a crevice nozzle or as a dusting brush. To select the desired setting rotate the end of the nozzle to change from crevice nozzle to dusting brush.

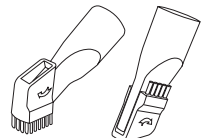

The crevice nozzle can be used for cleaning crevices, corners, between cushions or difficult to reach places. The dusting brush can be used to clean furniture, books, lamp shades and shelves.

EMPTYING THE DUST CONTAINER

Note: The dust container should be emptied after each vacuum cleaning, or as necessary, and when filter indicator lights up and stays on.

1. To remove the dust container, unlock it by pressing the two buttons situated on either side of the handle and pull it out.
2. Press the orange locking lever on the dust container to open the lid. To prevent dust escaping from the dust container, place the dust container inside a plastic bag before opening the lid.
3. Clean the dust container, close the lid ensuring that the orange locking lever clicks into position.
4. Replace the dust container by pushing it down lightly until the locking catch clicks into position.

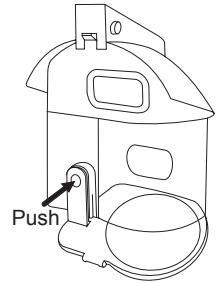

CLEANING OR REPLACING THE FILTERS

Caution: Before doing any type of cleaning or maintenance to the cleaner, always ensure that the cleaner is unplugged from the wall socket.

Damaged filters must be replaced immediately. Do not operate the cleaner with damaged or clogged filters. Do not clean the filters in a washing machine and do not use a hair dryer to dry the filters.

Do not use cleaning agents or hard bristled brushes as they may damage the delicate filter surfaces.

Dust container filters

Note: There are two filters in the dust container. A HEPA filter and a fine mesh cage filter. These two filters must be cleaned regularly. Check and if necessary clean or replace these filters each time that the dust container is emptied or when the filter indicator lights up and stays on.

Clogged filters can impair the performance of the cleaner or lead to malfunctions.

It is normal for the filter indicator to light up briefly when the cleaner is in operation.

1. Remove the dust container from the cleaner.

2. Open the dust container lid, twist and pull out the cage filter.

3. Remove the HEPA filter by rotating it counter clockwise.

4. Rinse both filters under running lukewarm water. Start by rinsing the inside of the filters first and then the outside. Repeat this operation until the filters are completely clean.

5. Allow the filters to air dry thoroughly before replacing them in the dust container.

6. Rinse and wipe dry the dust container before replacing the filters.

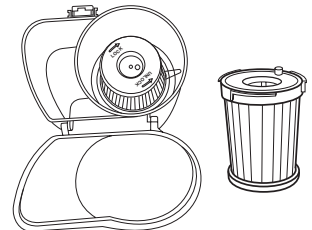
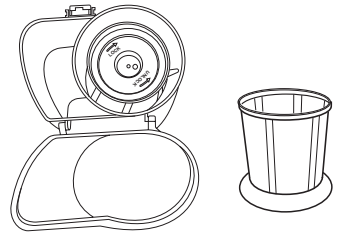

Note: When fitting the HEPA filter in the dust container ensure that the pin on the HEPA filter frame drops inside the slot at the bottom of the dust container.

Turn the HEPA filter frame clockwise to lock into position. This will retract the safety lever and allow the dust container to fit into the cleaner.

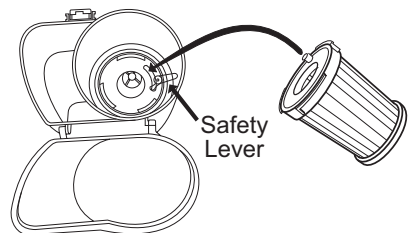

Exhaust filter

1. Open the air-outlet grille by pressing down on the grille latch and pull it out.
2. Remove the exhaust filter and replace it with a new one.
3. Close the air-outlet grille.

CLEANING AND STORING

Caution: Do not immerse the cleaner, in water or other liquids.

Do not wash the dust container in the dishwasher.

Do not use abrasive materials or solvents to clean the appliance as they may damage the surface finish.

1. Allow the appliance to cool down before cleaning.
2. Empty the dust container and ensure that the filters are cleaned.
3. Wipe the exterior of the appliance and the dust container with a damp cloth and then wipe it dry.

On model Z1660 (supplied with caddy fitted to telescopic extension tubes) the combination upholstery \ brush nozzle can be stored by attaching it to the caddy.

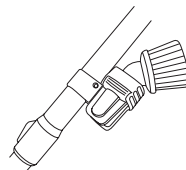

Note: The cleaner can be stored either horizontally or in an upright position.

With the hose and the extension tube attached to the combination floor nozzle, slide the parking clip of the floor nozzle onto one of the two parking positions on the cleaner.

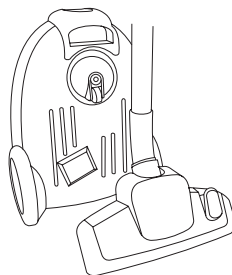
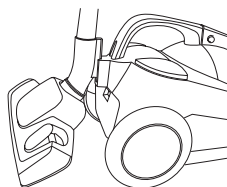

TROUBLE SHOOTING

The appliance does not operate

- The appliance may not be plugged into the wall socket.
- The wall socket may be switched off.

Filter indicator lights up and stays on

- The dust container is full. Empty the dust container and check the filters.
- The filters are clogged. Clean or replace the filters.

Loss of suction

- The hose, extension tubes or accessories may be blocked. Switch the cleaner off and unplug it from the wall socket. Remove the blockage.
- The Filters may be clogged. Clean or replace filters.
- The dust container is full. Empty the dust container and clean or replace the filters.

Cleaner switches off during operation.

Note: The motor is fitted with a thermal cut-out switch which will automatically switch off the cleaner if the motor starts to overheat.

Should this happen please do the following:

- Switch the cleaner off by pressing the on/off switch pedal and unplug it from the wall socket.
- Allow the cleaner to cool down for approximately 40 minutes.
- During this period, check for blockages in the hose, extension tubes and accessories. Check if the dust container is full or if the filters are clogged.
- Once the cleaner has cooled down, the thermal cut-out switch resets and the cleaner will be ready for use again.

Should the cleaner fail to operate, please contact your nearest authorized Electrolux service center.

