

WASHING MACHINE
洗衣機
MESIN BASUH

INSTRUCTION BOOKLET

說明手冊

BUKU PETUNJUK

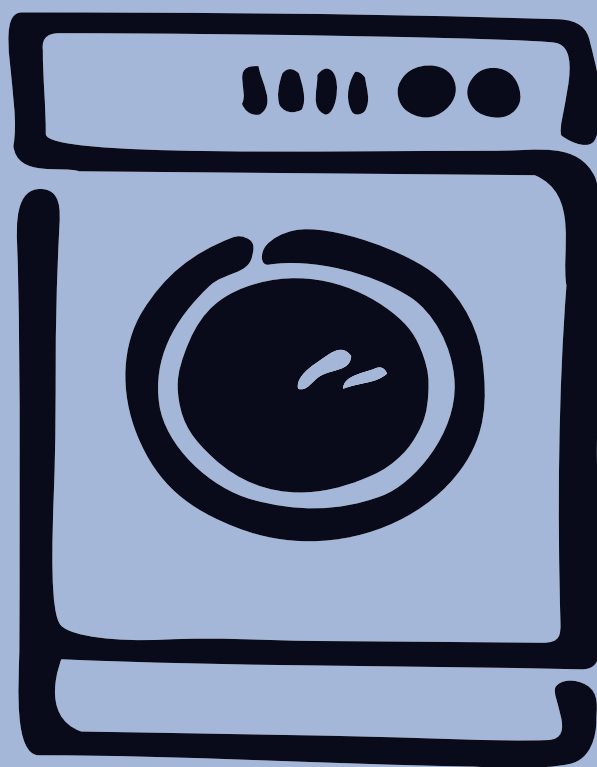

EW 880F

132 991 310

 **Electrolux**

GB

CN

MS



Dear customer,

Please read these operating instructions carefully and pay particular attention to the safety notes indicated in the first pages. We recommend that you keep this instruction booklet for future reference and pass it on to any future owners.

Transport damages

When unpacking the appliance, check that it is not damaged. If in doubt, do not use it and contact the Service Centre.

The symbols you will see on some paragraphs of this booklet have the following meaning:

-  The warning triangle and/or the key words (Warning!, Caution!) emphasize information that is particularly important for your safety or correct functioning of the appliance.
-  The information marked with this symbol provides additional instructions and practical tips on the use of the appliance.
-  Tips and information about economical and ecological use of the machine are marked with this symbol.

Our contribution to the protection of the environment: we use recycled paper.

Contents

Warnings	4-5	Maintenance	19-20
Disposal	5	Door seal	19
Tips for environmental protection	5	Bodywork	19
Technical specifications	6	Detergent dispenser drawer	19
Installation	7	Drain pump	20
Unpacking	7	Water inlet filter	20
Positioning and levelling	7	Emergency emptying out	20
Water inlet	7-8	Frost precautions	20
Water drainage	8		
Electrical connection	8	Something not working?	21-22
Your new washing machine	9		
Description of the appliance	9		
Detergent dispenser drawer	9		
Use	10		
Control panel	10		
Controls	10-11		
Washing hints	12		
Sorting the laundry	12		
Temperatures	12		
Before loading the laundry	12		
Maximum loads	12		
Laundry weights	12		
Removing stains	12		
Detergents and additives	13		
International wash code symbols	14		
Operating sequence	15-16		
Programme table	17-18		

ENGLISH

Warnings

The following warnings are provided in the interests of overall safety. You must read them carefully before installing or using the appliance.

Installation

- All internal packing must be removed before using the appliance. Serious damage may be caused to the machine or adjacent furniture if the protective transit devices are not removed or are not completely removed. Refer to the relevant paragraph in the instruction book.
- Any electrical work required to install this appliance must be carried out by a qualified electrician.
- Any plumbing work required to install this appliance must be carried out by a qualified plumber.
- After having installed the machine, check that it is not standing on its electrical supply cable.
- If the appliance is placed on a carpeted floor, ensure that air can circulate freely between the feet and the floor.

Use

- This appliance is designed for domestic use. It must not be used for purposes other than those for which it was designed.
- Only wash fabrics which are designed to be machine washed. Follow the instructions on each garment label.
- Do not overload the appliance. Follow the instructions in the instruction book.
- Make sure that all pockets are empty. Objects such as coins, safety pins, pins and screws can cause extensive damage.
- Do not machine wash garments saturated with petroleum, methylated spirits, trichlorethylene, etc. If such fluids have been used to remove stains prior to washing, wait until they have completely evaporated from the fabric before placing garments in the appliance.
- Place small items such as socks, belts, etc. in a cloth bag or pillowcase to prevent them getting trapped between the drum and the tub.
- Use only the recommended quantities of fabric softener. An excessive amount could damage the laundry.

- Leave the porthole door slightly ajar when the appliance is not in use. This preserves the door seal and prevents the formation of musty smells.
- Always check that water has emptied out before opening the door. If not, drain the water following the instructions in the instruction book.
- Always unplug the appliance and shut the water tap after use.

General safety

- Repairs to the machine must be carried out only by qualified personnel. Repairs carried out by inexperienced persons could cause serious danger. Contact your local Service Centre.
- Never pull the power supply cable to remove the plug from the socket; always take hold of the plug itself.
- During high temperature wash programmes the door glass may get hot. Do not touch it!

Child safety

- Children are often not aware of how dangerous electrical appliances can be. When the machine is working, children should be carefully supervised and not be allowed to play with the appliance.
- The packaging components (e.g. plastic film, polystyrene) can be dangerous to children - danger of suffocation! Keep them out of children's reach.
- Keep all detergents in a safe place out of children's reach.
- Make sure that children or pets do not climb into the drum. To avoid this the machine incorporates a special feature. To activate this device, rotate the button (without pressing it) inside the door clockwise until the groove is horizontal. If necessary use a coin.

To disable this device and restore the possibility of closing the door, rotate the button anti-clockwise until the groove is vertical.

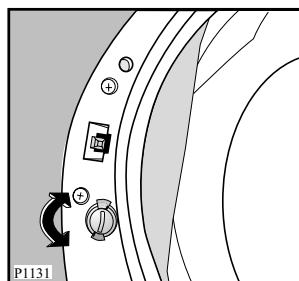

- When the appliance is to be scrapped, cut off the electrical supply cable and destroy the plug with the remaining cable. Disable the door catch in order to prevent children from becoming trapped inside while playing.

Disposal

Packaging materials

The materials marked with the symbol  are recyclable.

>PE<=polyethylene

>PS<=polystyrene

>PP<=polypropylene

This means that they can be recycled by disposing of them properly in appropriate collection containers.

Machine

Use authorised disposal sites for your old appliance. Help to keep your country tidy!

Tips for environmental protection

To save water, energy and to help protect the environment, we recommend that you follow these tips:

- Normally soiled laundry may be washed without prewashing in order to save detergent, water and time (the environment is protected too!).
- The machine works more economically if it is fully loaded.
- With adequate pre-treatment, stains and limited soiling can be removed; the laundry can then be washed at a lower temperature, so saving energy.
- Measure out detergent according to the water hardness, the degree of soiling and the quantity of laundry being washed.

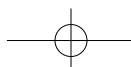

Technical specifications

DIMENSIONS	Height	85 cm
	Width	60 cm
	Depth	59 cm
MAXIMUM LOAD	Cotton	6.5 kg
	Synthetics	2.5 kg
	Delicates	2.5 kg
	Woollens	2 kg
SPIN SPEED		850 rpm max.
POWER SUPPLY VOLTAGE/FREQUENCY		230-240 V/50 Hz
TOTAL POWER ABSORBED		2050 W
MINIMUM FUSE PROTECTION		10 A
WATER PRESSURE	Minimum	50 kPa
	Maximum	800 kPa

CE This appliance complies with the following EEC Directives:
73/23/EEC of 19/02/73 relating to low voltage
89/336/EEC of 03/05/89 relating to electromagnetic compatibility.

Installation

Unpacking

 All transit bolts and packing must be removed before using the appliance.

You are advised to keep all transit devices so that they can be refitted if the machine ever has to be transported again.

1. Using a spanner, unscrew and remove the two rear bottom screws. Slide out the two plastic pins.

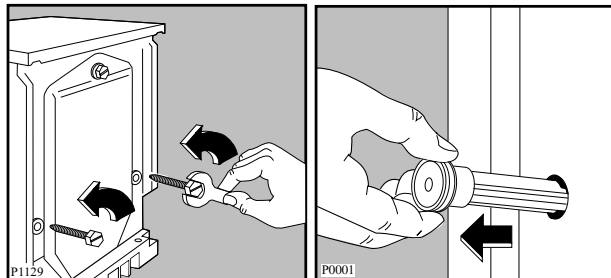

2. Lay the machine on its back, taking care not to squash the hoses. This can be avoided by placing one of the corner packing pieces between the machine and the floor.
3. Remove the polystyrene block(s) from the bottom of the machine. Unscrew and remove the four feet. Release the two plastic bags.
4. Very carefully slide out the left polythene bag, removing it towards the right and then downwards.

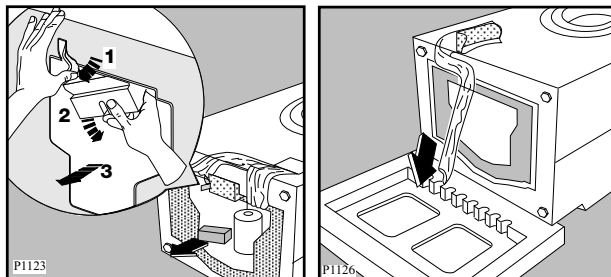

5. Very carefully slide out the right polythene bag, removing it towards the left and then upwards.
6. Fit the grid (A) on the bottom of the machine using the four screws (B) you will find in the bag containing the instruction booklet. Re-fit the feet.

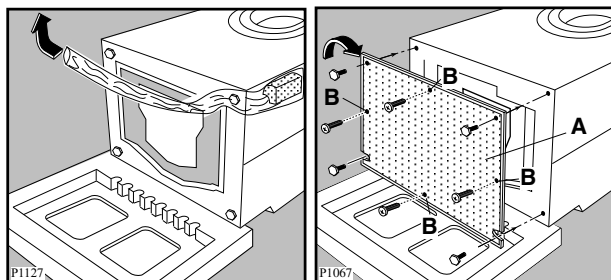

7. Set the machine upright and remove the remaining rear screw. Slide out the relevant pin.
8. Plug all the holes with the plugs which you will find in the envelope containing the instruction booklet.

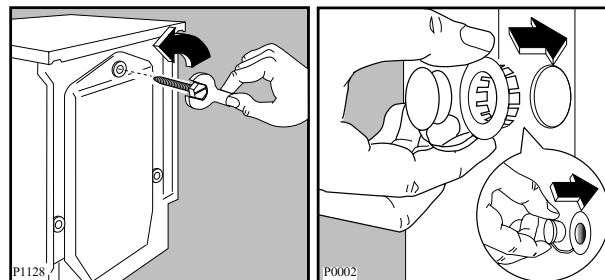

Positioning and levelling

Install the machine on a flat hard floor. Make sure that air circulation around the machine is not impeded by carpets, rugs etc. Check that the machine does not touch the wall or other kitchen units.

Carefully level by screwing the adjustable feet in or out. Never place cardboard, wood or similar materials under the machine to compensate for any unevenness in the floor.

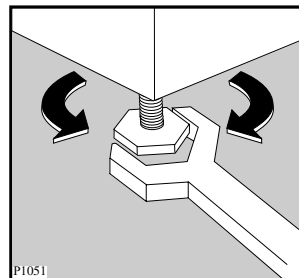

Water inlet

Connect the machine to a cold water tap with a 3/4" thread by means of the water inlet hose situated at the back of the appliance. Do not use to this purpose old hoses already employed

The other end of the inlet hose which connects to the machine can be turned in any direction. Simply loosen the fitting, rotate the hose and retighten the fitting, making sure there are no water leaks.

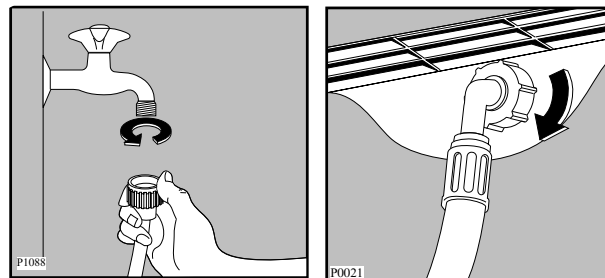

The inlet hose must not be lengthened. If it is too short and you do not wish to move the tap, you will have to purchase a new, longer hose specially designed for this type of use.

Important!

Before connecting up the machine to new pipework or to pipework that has not been used for some time, run off a reasonable amount of water to flush out any debris that may have collected in the pipes.

Water drainage

The end of the drain hose can be positioned in three ways:

Hooked over the edge of a sink using the plastic hose guide supplied with the machine. In this case, make sure the end cannot come unhooked when the machine is emptying. This could be done by tying it to the tap with a piece of string or attaching it to the wall.

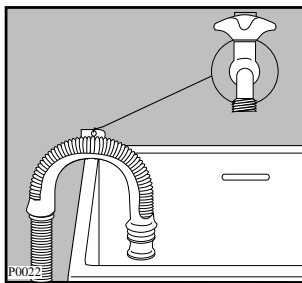

In a sink drain pipe branch. This branch must be above the trap so that the bend is at least 60 cm above the ground.

Directly into a drain pipe at a height of not less than 60 cm and not more than 90 cm. The end of the drain hose must always be **ventilated**, i.e. the inside diameter of the drain pipe must be larger than the outside diameter of the drain hose. The drain hose must not be kinked.

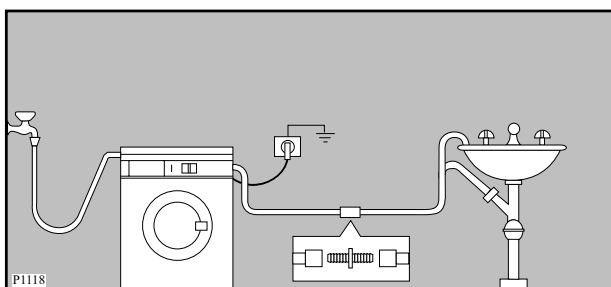

For a correct functioning of the machine the drain hose must remain hooked on the proper support piece situated on the top part of the back side of the appliance.

Electrical connection)

This machine is designed to operate on a 230-240 V, single-phase, 50 Hz supply.

Check that your domestic electrical installation can take the maximum load required (2.05 kW), also taking into account any other appliances in use.

WARNING: THIS APPLIANCE MUST BE EARTHED.
 ⚠ **The manufacturer declines any liability should this safety measure not be observed.**

The appliance is supplied with a 13amp plug fitted. In the event of having to change the fuse in the plug supplied, a 13amp ASTA approved (BS1363A) fuse must be used.

Should the plug need to be replaced for any reason, proceed as described below.

The wires in the mains lead are coloured in accordance with the following code:

- Green and Yellow - Earth
- Blue - Neutral
- Brown - Live

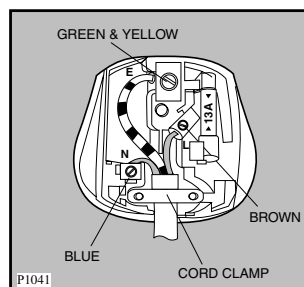

The wire coloured green and yellow must be connected to the terminal marked with the letter «E» or by the earth symbol = or coloured green and yellow.

The wire coloured blue must be connected to the terminal «N» or coloured black.

The wire coloured brown must be connected to the terminal marked «L» or coloured red.

Upon completion there must be no cut, or stray strands of wire present and the cord clamp must be secure over the outer sheath.

WARNING:
 ⚠ **A cut off plug inserted into a 13 amp socket is a serious safety (shock) hazard. Ensure that the cut off plug is disposed of safely.**

Your new washing machine

This new washing machine, which is fitted with the Jet system, patented Electrolux, meets all modern needs for effective treatment of laundry with low water, energy and detergent consumption.

Further savings are achieved by washing small loads of laundry, since water and electricity consumption is proportional to the quantity and type of laundry being washed.

- **The programme selector dial** combines the function of programme and temperature selection, making it easier to set the programme.
- **The programme progress display** shows the spin speed selected and the washing phase which is running.
- **The special wool programme** with its new delicate wash system treats your woollens with extreme care.
- **The automatic cooling of the washing water** from 90° to 60°C before draining will prevent old drain pipes from being deformed and will reduce thermal shock to fabrics, helping to prevent creasing.
- **The unbalance detection device** prevents vibration during spinning.
- **The ECO valve** allows total use of detergent and reduces water consumption so saving energy.

Description of the appliance

- 1 Detergent dispenser drawer
- 2 Control panel
- 3 Door handle
- 4 Drain pump
- 5 Adjustable feet

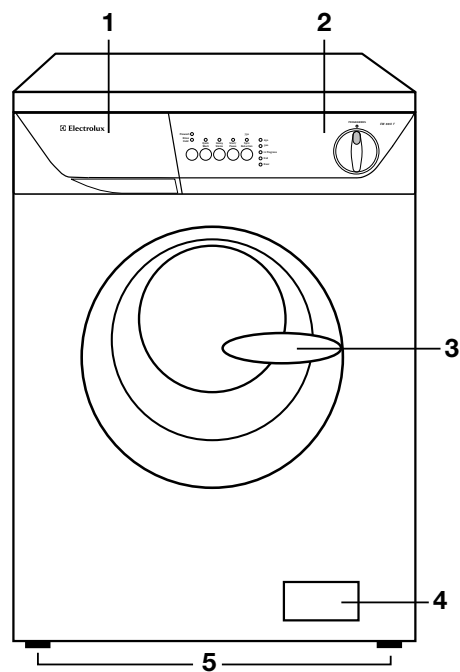

Detergent dispenser drawer

- Prewash
- Main wash
- Fabric softener, starch

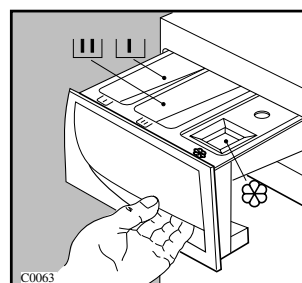

Use

Control panel

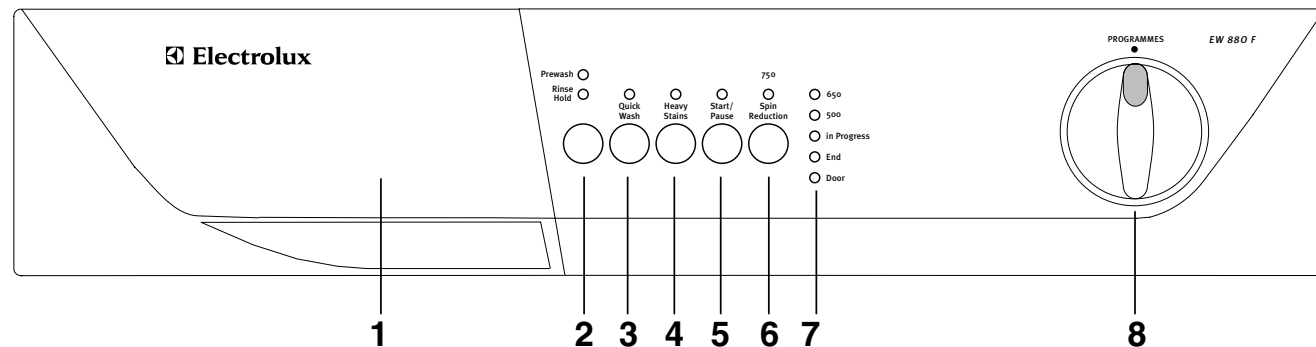

1 Detergent dispenser Drawer

Programme Option buttons

Depending on the programme, different functions can be combined. **These must be selected after choosing the desired programme and before depressing the START/PAUSE button.**

When these buttons are pressed, the corresponding pilot lights come on. When they are pressed again, the pilot lights go out.

If an incorrect option is selected, the pilot lights flash for about 2 seconds.

2 “Prewash / Rinse Hold” button

- Select **Prewash** option if you wish your laundry to be prewashed before the main wash (**not available for wool and hand wash**). The relevant light illuminates.

The prewash ends with a short spin in programmes for cotton and synthetic fabrics, whereas in the programme for delicate fabrics the water is only drained.

- When selecting **Rinse Hold** option, the water of the last rinse is not emptied out, to prevent the fabrics from creasing. The relevant light illuminates and will stay on during washing. At the end of the programme the pilot light **End** illuminates and the **Rinse Hold** light will remain lit. To drain water, proceed as follows:
 - turn the programme selector dial to position “O” to switch the machine off;
 - select programme (**drain**) or (**short spin**);
 - press **Start/Pause** button.

The light “**in Progress**” comes on during the drain or the spin programme. At the end of the programme the **End** light illuminates again.

3 “Quick Wash” button

This button allows you to select the Quick Wash function, for laundry that is only slightly soiled (**not for wool, hand wash and economy programme 60E**).

The washing time will be reduced according to the type of fabric and the selected temperature.

Max. load for cotton 3 kg.

4 “Heavy Stains” button

Select this button if you wish to add to the washing of heavy soiled laundry a stain phase: at the temperature of 40°C the special detergent for stains is loaded from the compartment marked .

This function is available in cotton and synthetic programmes with a temperature of 40° or higher).

The washing time will be prolonged by 5 minutes.

The **Prewash** and the **Heavy Stains** functions cannot be selected together.

5 “Start /Pause” button

After having selected the programme and the required options press this button to start the machine. The corresponding pilot light stops flashing and remains lit.

To interrupt a programme which is running, depress the **Start/Pause** button: the corresponding pilot light starts to flash.

To restart the programme from the point at which it was interrupted, **press the “Start/Pause” button again.**

6 “Spin reduction” button

By depressing this button you can reduce the max. spin speed proposed by the machine. The relevant light illuminates.

The maximum speeds are:

- for cotton, synthetics, hand wash and wool: 850 r.p.m.
- for delicate fabrics: 650 r.p.m.

7 Programme display

When you select the programme, the light corresponding to the selected speed or the various phases making up the programme come on.

Spin speed lights: are on during the washing programme and remain alight at the end of the cycle.

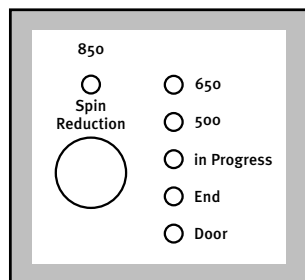

in Progress: when this light comes on this means that the machine is performing the washing programme. If you have selected the "Prewash" function, this light will be on during the prewash phase too. If you have selected the "Rinse Hold" function, this light will be on during washing.

End: when the programme has finished, the "End" pilot light comes on.

The "End" light flashes in the event of operating problems :

- 4 flashes: door open
- 2 flashes: problem with water draining
- 1 flash: problem with water supply

For more information see paragraph "Something not working"?

Door: the "Door" pilot light indicates if the door can be opened:

- light on: the door cannot be opened
- light off: the door can be opened

It stays on during the whole programme indicating that the door is locked.

When the light goes out, the door can be opened (see page 21)

8 Programme selector dial

The selector is divided into 5 sections:

- Cotton
- Synthetic
- Hand wash / Delicate
- Wool
- Special programmes
- Reset programme/OFF

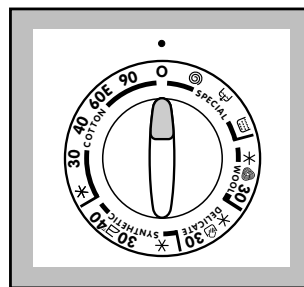

The selector dial can be turned either clockwise or anticlockwise.

Position **60E** corresponds to the ENERGY SAVING programme and position ***** to "cold wash".

At the end of the programme the selector dial must be turned to position "O" to switch the machine off.

Attention!

If during a washing programme the selector dial is turned to another programme, the pilot lights of the programme progress display start to flash. The machine will not perform the new selected programme.

i Washing hints

Sorting the laundry

Follow the wash code symbols on each garment label and the manufacturer's washing instructions. Sort the laundry as follows: whites, coloureds, synthetics, delicates, woollens.

Temperatures

90° for normally soiled white cottons and linen (e.g. tea cloths, towels, tablecloths, sheets...)

60° for normally soiled, colour fast garments (e.g. shirts, night dresses, pyjamas...) in linen, cotton or synthetic fibres and for lightly soiled white cotton (e.g. underwear).

X-cold for delicate items (e.g. net curtains),
30°-40° mixed laundry including synthetic fibres and woollens.

Before loading the laundry

Never wash whites and coloureds together. Whites may lose their "whiteness" in the wash.

New coloured items may run in the first wash; they should therefore be washed separately the first time.

Make sure that no metal objects are left in the laundry (e.g. hair clips, safety pins, pins).

Button up pillowcases, close zip fasteners, hooks and poppers. Tie any belts or long tapes.

Remove persistent stains before washing. Rub particularly soiled areas with a special detergent or detergent paste.

Treat curtains with special care. Remove hooks or tie them up in a bag or net.

Maximum loads

Recommended loads are indicated in the programme charts.

General rules:

Cotton, linen: drum full but not too tightly packed;

Synthetics: drum no more than half full;

Delicate fabrics and woollens: drum no more than one third full.

Washing a maximum load makes the most efficient use of water and energy.

For heavily soiled laundry, reduce the load size.

Laundry weights

The following weights are indicative:

bathrobe	1200 g
napkin	100 g
quilt cover	700 g
sheet	500 g
pillow case	200 g
tablecloth	250 g
towelling towel	200 g
tea cloth	100 g
night dress	200 g
ladies' briefs	100 g
man's work shirt	600 g
man's shirt	200 g
man's pyjamas	500 g
blouse	100 g
men's underpants	100 g

Removing stains

Stubborn stains may not be removed by just water and detergent. It is therefore advisable to treat them prior to washing.

Blood: treat fresh stains with cold water. For dried stains, soak overnight in water with a special detergent then rub in the soap and water.

Oil based paint: moisten with benzine stain remover, lay the garment on a soft cloth and dab the stain; treat several times.

Dried grease stains: moisten with turpentine, lay the garment on a soft surface and dab the stain with the fingertips and a cotton cloth.

Rust: oxalic acid dissolved in hot water or a rust removing product used cold. Be careful with rust stains which are not recent since the cellulose structure will already have been damaged and the fabric tends to hole.

Mould stains: treat with bleach, rinse well (whites and fast coloureds only).

Grass: soap lightly and treat with bleach (whites and fast coloureds only).

Ball point pen and glue: moisten with acetone (*), lay the garment on a soft cloth and dab the stain.

Lipstick: moisten with acetone as above, then treat stains with methylated spirits. Remove any residual marks from white fabrics with bleach.

Red wine: soak in water and detergent, rinse and treat with acetic or citric acid, then rinse. Treat any

residual marks with bleach.

Ink: depending on the type of ink, moisten the fabric first with acetone (*), then with acetic acid; treat any residual marks on white fabrics with bleach and then rinse thoroughly.

Tar stains: first treat with stain remover, methylated spirits or benzine, then rub with detergent paste.

(* **do not use acetone on artificial silk.**)

Detergents and additives

Good washing results also depend on the choice of detergent and use of the correct quantities to avoid waste and protect the environment. Although biodegradable, detergents contain substances which, in large quantities, can upset the delicate balance of nature.

The choice of detergent will depend on the type of fabric (delicates, woollens, cottons, etc.), the colour, washing temperature and degree of soiling.

All commonly available washing machine detergents may be used in this appliance:

- powder detergents for all types of fabric,
- powder detergents for delicate fabrics (60°C max) and woollens,
- liquid detergents, preferably for low temperature wash programmes (60°C max) for all types of fabric, or special for woollens only.

The detergent and any additives must be placed in the appropriate compartments of the dispenser drawer before starting the wash programme.

If using concentrated powder or liquid detergents, a programme **without** prewash must be selected.

The washing machine incorporates a recirculation system which allows an optimal use of the concentrated detergent.

Pour liquid detergent into the dispenser drawer compartment marked  **just before** starting the programme.

Any fabric softener or starching additives must be poured into the compartment marked  before starting the wash programme.

Follow the product manufacturer's recommendations on quantities to use and **do not exceed the «MAX» mark in the detergent dispenser drawer.**

Quantity of detergent to be used

The type and quantity of detergent will depend on the type of fabric, load size, degree of soiling and hardness of the water used.

Water hardness is classified in so-called "degrees" of hardness. Information on hardness of the water in your area can be obtained from the relevant water supply company, or from your local authority.













Follow the product manufacturers' instructions on quantities to use.



Use less detergent if:





- you are washing a small load,
- the laundry is lightly soiled,
- large amounts of foam form during washing.





(i) International wash code symbols







These symbols appear on fabric labels, in order to help you choose the best way to treat your laundry.

Energetic wash   Delicate wash	 Max. wash temperature 95°C	 Max. wash temperature 60°C	 Max. wash temperature 40°C	 Max. wash temperature 30°C	 Hand wash	 Do not wash at all
	 Max. wash temperature 60°C	  Max. wash temperature 40°C	 Max. wash temperature 30°C			

 Bleaching	 Bleach in cold water	 Do not bleach
---	---	--

 Ironing	 Hot iron max 200°C	 Warm iron max 150°C	 Lukewarm iron max 110°C	 Do not iron
---	---	---	--	--

 Dry cleaning	 Dry cleaning in all solvents	 Dry cleaning in perchlorethylene, petrol, pure alcohol, R 111 & R 113	 Dry cleaning in petrol, pure alcohol and R 113	 Do not dry clean
--	---	---	---	---

 Drying	 Flat	 On the line	 On clothes hanger	 high temperature  low temperature Tumble dry	 Do not tumble dry
--	---	--	--	---	--

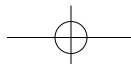

i Operating sequence

Before the first wash we recommend that you pour 2 litres of water into the main wash compartment  of the detergent drawer in order to activate the ECO valve. Then run the cotton cycle 60°E, with the machine empty, in order to remove any manufacturing residue from the drum and tub. Pour half a measure of detergent into the main wash compartment and start up the machine.

1. Place the laundry in the drum

Open the door.

Place the laundry in the drum, one item at a time, shaking them out as much as possible.

Close the door.

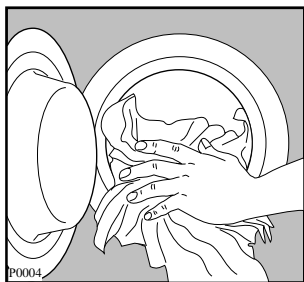

2. Measure out the detergent

Pull out the dispenser drawer until it stops. Measure out the amount of detergent recommended by the manufacturer in a graduated cup and pour it into the main wash compartment .

If you wish to carry out the prewash or a stain phase, pour detergent into the appropriate compartment marked .

3. Measure out the additive

If required, pour fabric softener into the compartment marked , without exceeding the «MAX» mark.

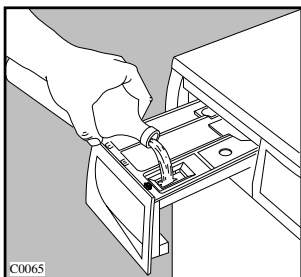
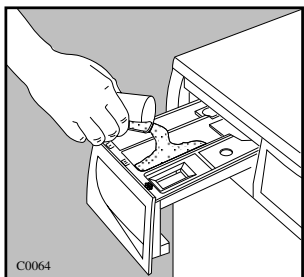

4. Select the desired programme

Turn the programme selector dial to the desired position.

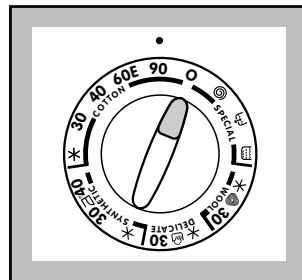

The light corresponding to the max spin speed for the selected programme illuminates and the light of the **Start/Pause** button starts to flash.

5. Select the required option(s)

The light corresponding to the depressed button illuminates.

When selecting the **Rinse Hold option** the water of the last rinse is not emptied out, to prevent the fabrics from creasing.

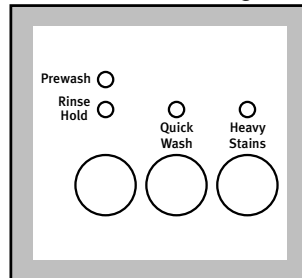

6. Reduce eventually the spin speed

Press the **Spin Reduction** button repeatedly to reduce the spin speed.

The relevant light illuminates.

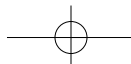
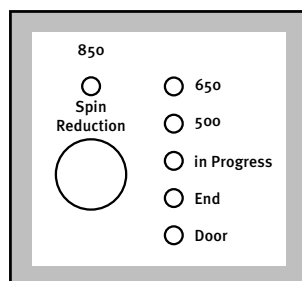

7. Start the programme

To start the selected programme, press the **Start/Pause** button; the corresponding light stops flashing.

The **"in Progress"** light illuminates.
The machine starts operating.

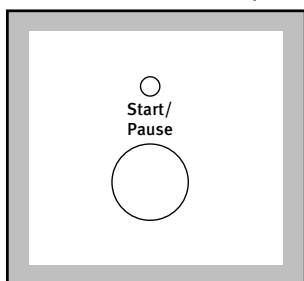

8. Altering a programme

You can alter the programme before it starts. When the programme has started, you can only reset it by turning the programme selector dial to **O** and then you can select the new programme. The washing water remains in the tub. Start the new programme by depressing the **Start/Pause** button.

9. Interrupting a programme

Depress the **Start/Pause** button to interrupt a programme which is running, the corresponding light starts to flash. Depress the button again to restart the programme.

10. Cancelling a programme

Turn the selector dial to **O** to cancel a programme which is running. Now you can select a new programme.

11. Opening the door after the programme has started

First set the machine to PAUSE by pressing the **Start/Pause** button.

The door can be opened when the **Door** light has gone out.



If the door does not open, this means that the water temperature is above 55°C, that the water level is above the bottom edge of the door or that the drum is turning.

If you cannot open the door but you need to open it you have to switch the machine off by turning the programme selector dial to **"O"**. After about 3 minutes the door can be opened (pay attention to the water level and temperature!). Select the programme again and depress **Start/Pause** to restart it.

12. At the end of the programme

The machine stops automatically.

If the **Rinse Hold** option has been selected, the **"End"** and **"Door"** phase lights are on to indicate that the water must be emptied out before opening the door.

To do this first turn the programme selector dial to **"O"** and then to drain programme  or spin programme . The spin programme is performed at the maximum speed. In order to avoid any creasing or damage in synthetic, delicate, hand wash and wool items, the spin speed must be reduced by means of the relevant button.

The door can only be opened after the **Door** light has gone out.

Release of the lock is also indicated by the coming on of the **End** light.

At the end of the programme turn the programme selector dial to **"O"** to switch the machine off.

Remove the laundry from the drum and carefully check that the drum is empty.

If you do not intend to carry out another wash, close the water tap. Leave the door open to prevent the formation of mildew and unpleasant smells.

Programme table

Fabrics	Temperature/ Programme	Type of laundry	Additional functions
White cotton	90° COTTON	Sheets, household linen, towels, tablecloths	Prewash Rinse Hold Quick Wash Heavy Stains Spin reduction
White cotton economy	60E COTTON	Hand towels, sheets, underwear, tablecloths	Prewash Rinse Hold Heavy Stains Spin reduction
Coloured cotton	40° - 30° COLD ✕ COTTON	Fast coloured cottons e.g. hand towels, sheets Non-fast coloured items, for example underwear, shirts, blouses	Prewash Rinse Hold Quick Wash Heavy Stains** Spin reduction
Synthetics	40° SYNTHETICS	Shirts, blouses, easy to iron	Prewash Rinse Hold Quick Wash Heavy Stains Spin reduction
Synthetics	30° - COLD ✕ SYNTHETICS	Shirts, blouses, underwear, mixed fabrics	Prewash Rinse Hold Quick Wash Spin reduction
Hand wash	 30° DELICATES	Special programme for articles of cloths with hand wash label 	Rinse Hold Spin reduction
Delicates	COLD ✕ DELICATES	Acrylic, viscose, polyester items, curtains	Prewash Rinse Hold Quick Wash Spin reduction
Wool 	 30° - COLD ✕ WOOL	Special programme for garments bearing the "Pure new wool, non-shrink, machine washable" label	Spin reduction Rinse Hold





Economy programme

For slightly/normally soiled cottons you can use the relevant Economy programme: you will obtain good washing results by saving energy.

** Only with a temperature of 40°C and higher.

Programme table

Special programmes

Programme selector dial position	Programme	Programme description	Additional functions
 Rinses	For rinsing hand washed items	3 rinses with liquid additive, if required Short spin at max. speed	Spin Reduction Rinse Hold
 Drain	For emptying out the water of the last rinse of programmes with RINSE HOLD option	Water draining	
 Spin	Separate spin for all fabrics	Short spin at max. speed	Spin Reduction
 Reset/Off	For cancelling the programme which is running or to switch the machine off.		

Maintenance

1. Door seal

Check from time to time the door seal and eliminate eventual possible objects that could be trapped in the fold.

Important: do not use methylated spirits, solvents or similar products to clean the bodywork.

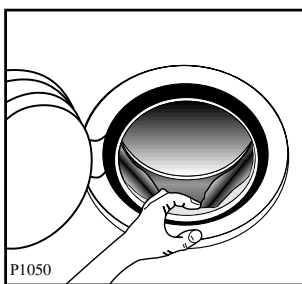

2. Bodywork

Clean the outside of the machine with warm water and a neutral, non-abrasive household detergent. Rinse with clean water and dry with a soft cloth.

Important: do not use methylated spirits, solvents or similar products to clean the bodywork.

3. Detergent dispenser drawer

After a while, detergents and fabric softeners leave deposits in the drawer.

Clean the drawer from time to time by rinsing it under a running tap. To remove the drawer from the machine, press the button in the rear left-hand corner.

To facilitate cleaning, the top part of the additive compartment can be removed.

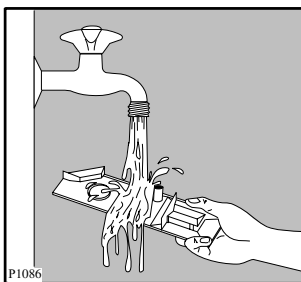
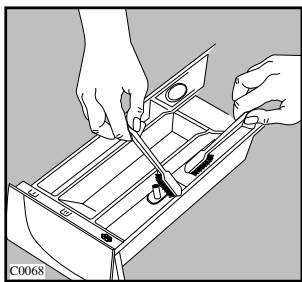
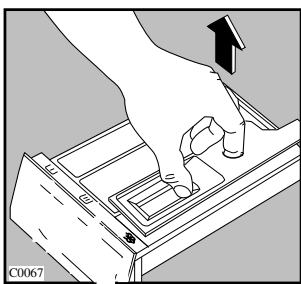
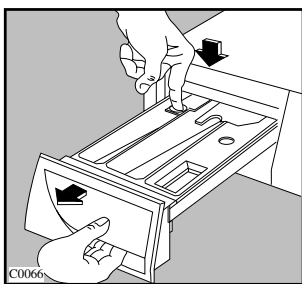

Detergent can also accumulate inside the drawer recess: clean it with an old toothbrush. Refit the drawer after cleaning.

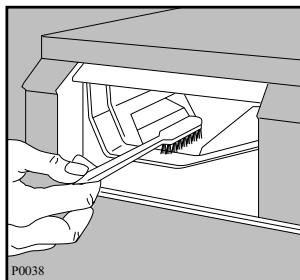

4. Drain pump

The pump should be inspected if

- the machine does not empty and/or spin
- the machine makes an unusual noise during draining due to objects such as safety pins, coins etc. blocking the pump.

Proceed as follows:

- Disconnect the appliance.
- If necessary wait until the water has cooled down.
- Open the pump door.

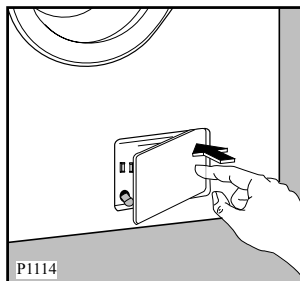

- Place a container close to the pump to collect any spillage.
- Release the emergency emptying hose, place it in the container and remove its cap.
- When no more water comes out, unscrew the pump and remove it. Always keep a rag nearby to dry up spillage of water when removing the pump.

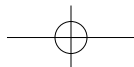
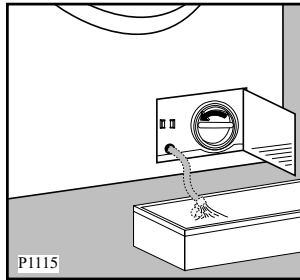

- Remove any objects from the pump impeller by rotating it.

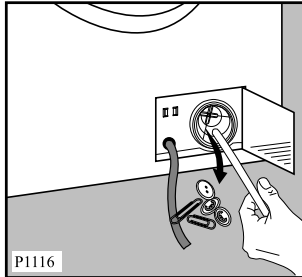

- Put the cap back on the emergency emptying hose and place the latter back in its seat.

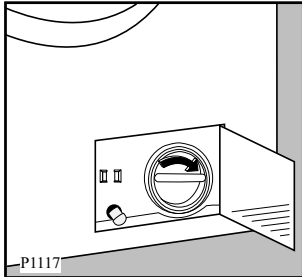

- Screw the pump fully in.
- Close the pump door.

5. Water inlet filter

If you notice that the machine is taking longer to fill, check that the filter in the water inlet hose is not blocked.

Turn off the water tap.

Unscrew the hose from the tap.

Clean the filter with a stiff brush.

Screw the hose back onto the tap.

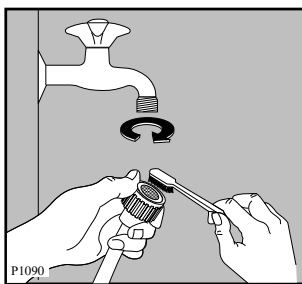

6. Emergency emptying out

If the water is not discharged, proceed as follows to empty out the machine:

- pull out the plug from the power socket;
- close the water tap;
- if necessary, wait until the water has cooled down;
- open the the pump door;
- place a bowl on the floor and place the end of the emergency emptying hose into the bowl. Remove its cap. The water should drain by gravity into the bowl. Whe the bowl is full, put the cap back on the hose. Empty the bowl. Repeat the procedure until water stops flowing out;
- clean the pump if necessary as previously described;
- replace the emergency emptying hose in its seat after having plugged it;
- screw the pump again and close the door.

7. Frost precautions

If the machine is installed in a place where the temperature could drop below 0°C, proceed as follows:

- Remove the plug from the socket.
- Close the water tap and unscrew the water inlet hose from the tap.
- Place the end of the emergency emptying hose and that of the inlet hose in a bowl placed on the floor and let water drain out.
- Screw the water inlet hose back on and reposition the emergency emptying hose after having put the cap on again.

By doing this, any water remaining in the machine is removed, avoiding the formation of ice and, consequently, breakage of the affected parts.

When you use the machine again, make sure that the ambient temperature is above 0°C.

Important!

Every time you drain the water through the emergency emptying hose you must pour 2 litres of water into the main wash compartment of the detergent drawer and then run the drain programme. This will activate the ECO valve avoiding that part of the detergent remains unused at next washing.

Something not working?

Problems which you can resolve yourself.

During machine operation it is possible that one of the **End** light starts to flash:

4 flashes= the door has not been closed

2 flashes= the machine does not empty

1 flash= the machine does not fill.

Once the problem has been eliminated, press the START/PAUSE button to restart the programme. If after all checks, the problem persists, contact your local Service Centre.

Problem	Possible cause
<ul style="list-style-type: none"> • The machine does not start up: 	<ul style="list-style-type: none"> • The door is not firmly closed. • The machine is not plugged in or there is no power at the socket. • The main fuse or the fuse in the plug has blown. • The START/PAUSE button has not been depressed. • The programme selector dial is not positioned correctly.
<ul style="list-style-type: none"> • The machine does not fill: 	<ul style="list-style-type: none"> • The water tap is closed. • The inlet hose is squashed or kinked. • The filter in the inlet hose is blocked.
<ul style="list-style-type: none"> • The machine fills then empties immediately: 	<ul style="list-style-type: none"> • The end of the drain hose is too low. Refer to relevant paragraph in "water drainage" section.
<ul style="list-style-type: none"> • The machine does not empty and/or does not spin: 	<ul style="list-style-type: none"> • The drain hose is squashed or kinked. • The option Rinse Hold has been selected. • The drain pump is clogged. • The laundry is not evenly distributed in the drum.
<ul style="list-style-type: none"> • There is water on the floor: 	<ul style="list-style-type: none"> • Too much detergent or unsuitable detergent (creates too much foam) has been used. • Check whether there are any leaks from one of the inlet hose fittings. It is not always easy to see this as the water runs down the hose; check to see if it is damp. • The drain hose is damaged. • The cap on the emergency emptying hose has not been replaced after cleaning the filter. • The pump has not been fully screwed in after cleaning.
<ul style="list-style-type: none"> • Unsatisfactory washing results: 	<ul style="list-style-type: none"> • Too little detergent or unsuitable detergent has been used. • Stubborn stains have not been treated prior to washing. • The correct programme or temperature was not selected. • Excessive laundry load.
<ul style="list-style-type: none"> • The machine vibrates or is noisy: 	<ul style="list-style-type: none"> • The transit bolts and packing have not been removed. • The support feet have not been adjusted.

Problem	Possible cause
<ul style="list-style-type: none"> • The door will not open: 	<ul style="list-style-type: none"> • The programme is still running, the drum is turning. • The door lock has not yet released. • The water level is above the bottom edge of the door. • There is water in the drum. <p>The door can only be opened when the relevant light has gone out.</p>
<ul style="list-style-type: none"> • Spinning starts late or the laundry is not spun enough: 	<ul style="list-style-type: none"> • The electronic unbalance detection device has cut in because the laundry is not evenly distributed in the drum. The laundry is redistributed by reverse rotation of the drum. This may happen several times before the unbalance disappears and normal spinning can resume. If, after few minutes, the laundry is still not evenly distributed in the drum, the machine will spin at a lower speed or will not spin. If at the end of the programme the laundry is not spun enough, redistribute the load manually and select the spin programme.

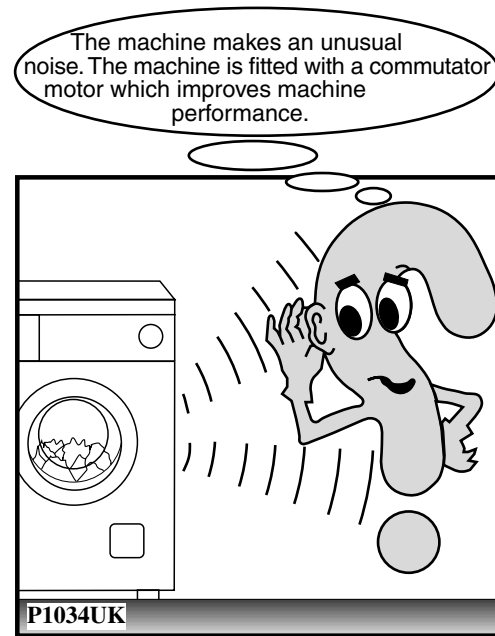
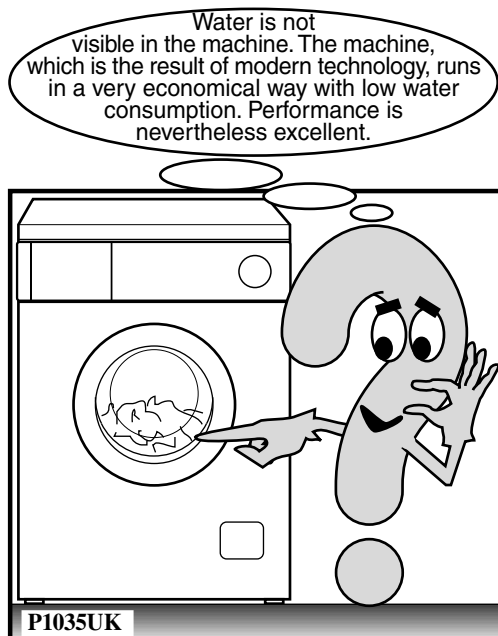

If you are unable to identify or solve the problem, contact our service centre. Before telephoning, make a note of the model, serial number and purchase date of your machine: the Service Centre will require this information.

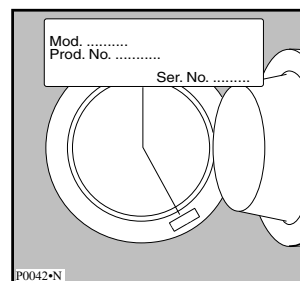



 **The Electrolux Group. The world's No. 1 choice.**

The Electrolux Group is the world's largest producer of powered appliances for kitchen, cleaning and outdoor use. More than 55 million Electrolux Group products (such as refrigerators, cookers, washing machines, vacuum cleaners, chain saws and lawn mowers) are sold each year to a value of approx. USD 14 billion in more than 150 countries around the world.

